

USER MANUAL FOR



CK1200TU, CK1400TU, CK1600TU, CK1800TU & CK2000TU



CATER KWIK, The Lakeland Catering Centre, Newlands, Ulverston, Cumbria, LA12 7QQ
Tel: 01229 480001 | E-mail: info@caterkiwk.co.uk
www.caterkiwk.co.uk



Contents

Please take a few moments to read carefully through this manual; correct maintenance and operation of this machine will provide the best possible performance and efficiency.

	Page No.
<u>Contents:</u>	2
Safety Notice	3
Installation	4-5
Operation	6
Cleaning & Maintenance	7
Trouble Shooting	8
Technical Data	9
	10



Safety Notice

Before operating or installing the appliance, please read thoroughly through this manual and retain for future reference.

- Position on a flat, stable surface.
- A qualified technician should carry out any repairs should they be required.
- Consult Local and National Standards to comply with the following:
 - Health and Safety at Work Legislation
 - Fire Precautions.
 - IEE Wiring Regulations.
 - Building Regulations.
- This appliance is intended for commercial use.
- Do not use the appliance outdoors.
- Do not attempt to service the appliance yourself.
- Do not use this appliance if it appears to be damaged. If in doubt, consult a qualified technician.
- Do not use electrical appliances inside the unit (e.g. heaters, ice-cream makers etc).
- Ensure that the appliance had sufficient room for ventilation.
- Do not use mechanical devices or other means to accelerate the defrosting process.
- Do not damage the refrigerant circuit.
- Do not stand or support yourself on the appliance or glass panel.
- Do not use this appliance to store medical supplies.

- Do not allow oil or fat to come into contact with plastic components. Clean immediately if contact occurs.
- Do not place combustible, explosive or volatile articles, corrosives, alkalis or liquids into the unit.
- Do not use jet/pressure washers to clean the appliance.
- Do not allow children to play with the packaging, and dispose of plastic bags immediately.
- Always carry, store and handle the appliance in a vertical position and move by holding the base of the appliance.
- Always switch off and disconnect the power supply to the unit before cleaning.
- If the supply cord is damaged, it must be replaced by a qualified technician in order to avoid hazard.
- Children should be supervised to ensure that they do not play with the appliance.
- To guarantee safe operation, ensure that the appliance is set up and connected as described in the instruction manual.
- This appliance can be used by children from 8 years & above, and people with reduced physical sensory or mental capabilities, lack of experience and knowledge if they are supervised or have been given instruction concerning use of the appliance in a safe way and understand the hazards involved. Children shall not play with the appliance. Cleaning and user maintenance shall not be made by children without supervision.
- Sound pressure level at workstation is far below 70dB.

Setting Up Your Topping Unit

Installation

- Remove the appliance from the packaging. Make sure all protective plastic film and coatings are thoroughly removed from all surfaces.
- To prevent injury or damage to the unit, the appliance should be unpacked and set up by two people.
- Maintain a distance of 20cm (7") between the unit and walls or other objects for ventilation. Increase this distance if the unit is being placed next to a heat source.
- Level the appliance adjusting the threaded feet. It should be placed on a level, solid floor or base to reduce the vibration and noise.
- The ambient temperature where the unit is placed should not be outside the range of +10 ~ +32°C. Avoid locating the unit in direct sunlight or near a heat source such as an oven or radiator.
- Please make sure the appliance is properly ventilated.
- Power supply and voltage at the operating point must comply with the details on the rating label. The plug must be accessible after installation.
- Correctly connect and disconnect the plug. When inserting the plug ensure it is fully inserted into the socket outlet. When pulling out the plug, grip the plug body; never pull the supply cord directly.
- If the showcase is to be shut down for a long period of time, switch it off and disconnect the plug from the socket outlet. Clean the appliance and leave the lid open to prevent odour.
- For your safety, this appliance must be properly grounded. This appliance is equipped with a cord that has both grounded (earthing) wire and a grounding plug. The plug must be inserted into an outlet that is properly grounded and installed. Consult a qualified electrician or service centre if you do not completely understand the grounding instructions. If you are in doubt of whether the appliance is properly grounded, have a qualified electrician check over the circuit to make sure the outlet is safe and properly grounded.
- If the cable does not reach the nearest socket, either rearrange your room layout or ask a qualified technician to fit a new socket.
- If the power is cut off, wait at least 3 minutes before restarting the unit to avoid damage to the compressor.

Setting Up Your Topping Unit

Fitting the Glass Panels

ATTENTION: HANDLE WITH CARE - RISK OF BREAKING THE GLASS PANELS

Note: Ensure the hole in the collar for the grub screw faces inwards.

Note: Ensure the screw hole furthest from the edge of the panel goes to the back of the appliance.

Note: Ensure the soft end of the grub screw is the end making contact with the glass.

Note: Ensure the short end of the bolt assembly is on the outside of the panels.

Note: The glass panel must not be used as a shelf.

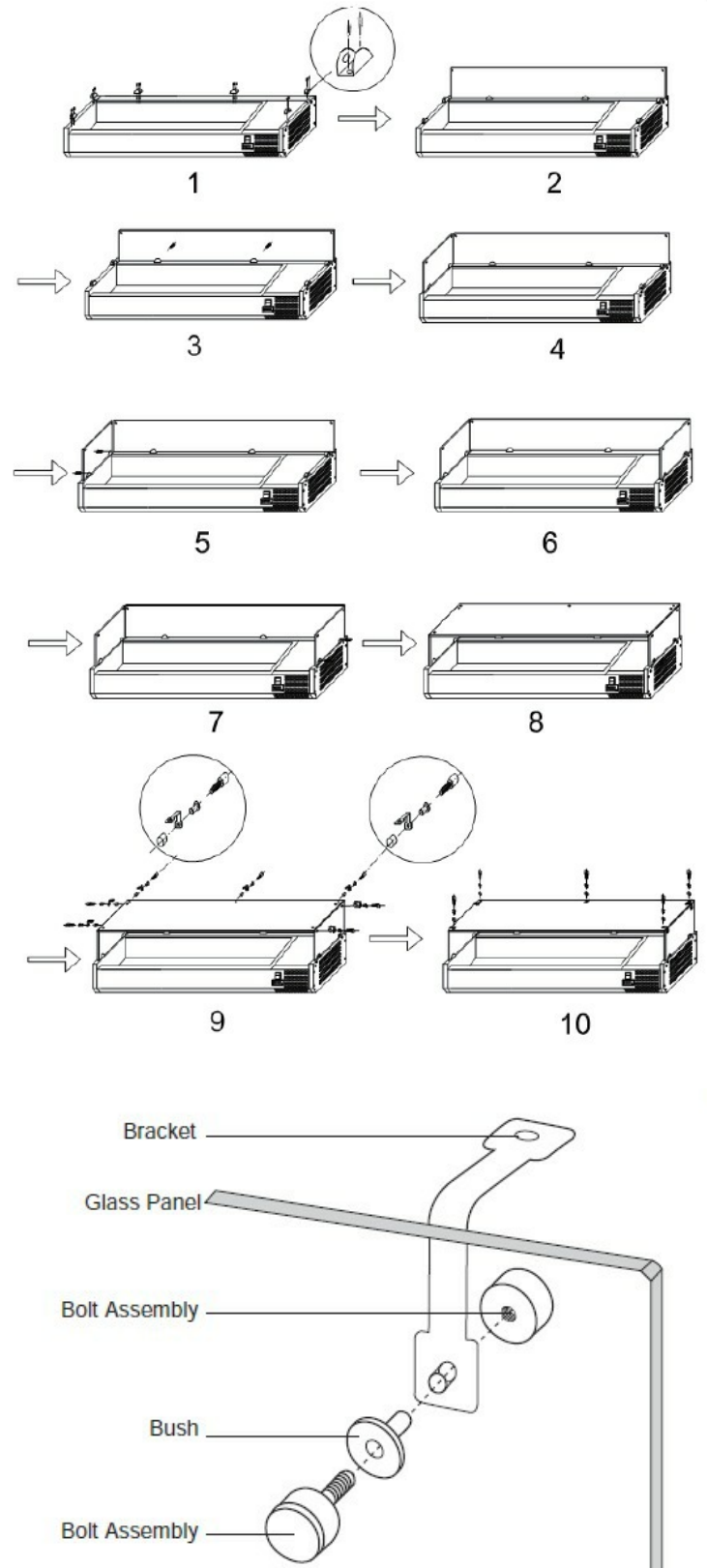

- Unpack the wooden/carton box carefully; it is recommended to do this work with two people.
- Screw the collars to the rim of the appliance.
- Slot the two side panels into the collars, with the holes in the glass at the top.
- Screw a grub screw into each collar to secure the panels.
- Slot the rear panel into the collars, with the holes in the glass at the top.
- Screw a grub screw into each collar and secure the panel.
- Slot the plastic bushes into each of the holes.
- Screw the brackets to the inside of each panel using the bolt assemblies.
- Place the top panel onto the brackets, ensuring all holes are aligned.
- Insert the bush and attach the top panel to the brackets with the bolt assemblies.

Glass Panel Assembly Diagram



Operation

Turning on your Topping Unit

- Ensure the power switch is set to “off”  and turn on at the wall socket.
- Switch the power on the appliance to on . The current internal temperature of the appliance will be displayed.
- The  symbol on the control panel will flash for 3 minutes due to the start delay timer which prevents overheating of the re-starting compressor.

Temperature setting & control

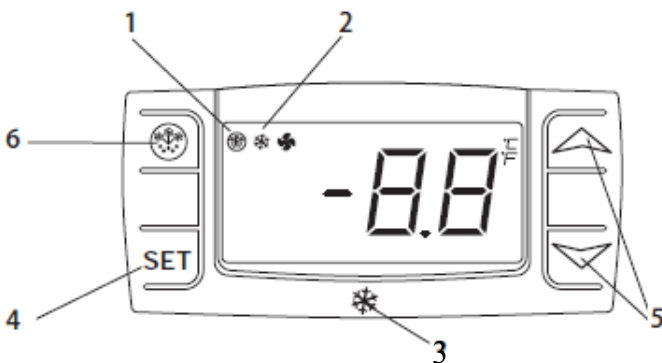

The front panel of the thermostat.

1. Defrosting light
2. Compressor operation light
3. Digital thermostat
4. Programming key
5. Temperature modification keys
6. Manual defrost

How to see the set point

- Push and immediately release the SET key, the set point will be shown
- Push and immediately release the SET key, or alternatively wait approx. 5 seconds for the display to return to normal visualisation.

How to change the set point

- Push the SET key for more than 2 seconds to change the set point value.
- The value of the set point will be displayed and the “°C” will start flashing.
- To change the set value push the UP or DOWN arrows within 10 seconds.
- To memorise the new set point value push the SET key again, or wait 10 seconds.

Manual Defrost

The appliance will automatically run a defrost cycle every 12 hours.

Note: The cycle starts from when the appliance is initially powered up.

To manually defrost the appliance:

- Press and hold the DEFROST  button for 5 seconds.
- The defrost cycle will start immediately and the defrost LED will illuminate. The defrost will last 20 minutes.

Note: Starting a manual defrost also resets the automatic defrost timer. The next automatic defrost will start 12 hours after the manual defrost.

Cleaning, Maintenance & Troubleshooting

Routine Cleaning & Maintenance

Attention - TO ENSURE SAFE, RELIABLE & EFFICIENT PERFORMANCE, YOUR APPLIANCE MUST BE CLEANED AND MAINTAINED REGULARLY.

Note: Switch off and disconnect from the power supply before cleaning.

- Clean the enclosure and interior of the appliance as often as possible.
- Wipe the unit with a moist cloth. Never allow the switch, control panel, cable or plug to get wet.
- DO not use abrasive cleaning agents. These can leave harmful residues. Use only mild soapy water to clean the appliance.
- Ensure that no cleaning water penetrated into the electrical components.
- The appliance must not be cleaned with a jet/power washer.
- Always wipe dry after cleaning with a wet cloth.
- Take care when cleaning the rear of the appliance.
- A qualified technician must carry out any

Troubleshooting

Fault: The appliance is not working.

Probable Cause	Action
The unit is not switched on .	Check that the unit is plugged in correctly and switched on.
Plug and lead are damaged.	Call your qualified technician.
Fuse in the plug has blown.	Replace the fuse.
Power supply.	Check power supply.
Internal wiring fault.	Call your qualified technician.

Fault: The appliance turns on, but the temperature is too high/low.

Probable Cause	Action
Too much ice on the evaporator.	Defrost the appliance.
Condenser is blocked with dust.	Call your qualified technician.
Appliance is located near a heat source or air flow to the condenser is being interrupted.	Move the refrigerator to a more suitable location.
Ambient temperature is too high.	Increase the ventilation or move the appliance to a cooler location.
Unsuitable goods are being stored.	Remove any excessive hot foods or blockages to the fan.
Appliance is overloaded.	Reduce the amount of goods stored in the appliance.

Fault: The appliance is unusually loud.

Probable Cause	Action
Loose nut/screw.	Check & tighten all nuts & screws.
The appliance has not been installed in a level or stable position/	Check installation position and change if necessary.

Technical Data

Model	CK1200TU	CK1400TU	CK1600TU	CK1800TU	CK2000TU
External Dimensions (mm) W x D x H	1200 x 335 x 225	1400 x 335 x 225	1600 x 335 x 225	1800 x 335 x 225	2000 x 335 x 225
Weight (kg)	25	27	30	32	34
Weight Packed (kg)	29	31.5	34.5	37	39
Voltage (V/Hz)	220~240/52	220~240/53	220~240/55	220~240/56	220~240/57
Temperature Range (°c)	+2 ~ +10	+2~ +10	+2 ~ +10	+2 ~ +10	+2 ~ +10
Capacity (1/4 GN)	5	6	7	8	10
Refrigerant	R134a	R134a	R134a	R134a	R134a
Condensing Unit	With fan	With fan	With fan	With fan	With fan
Digital thermostat	Yes	Yes	Yes	Yes	Yes

Circuit Diagram

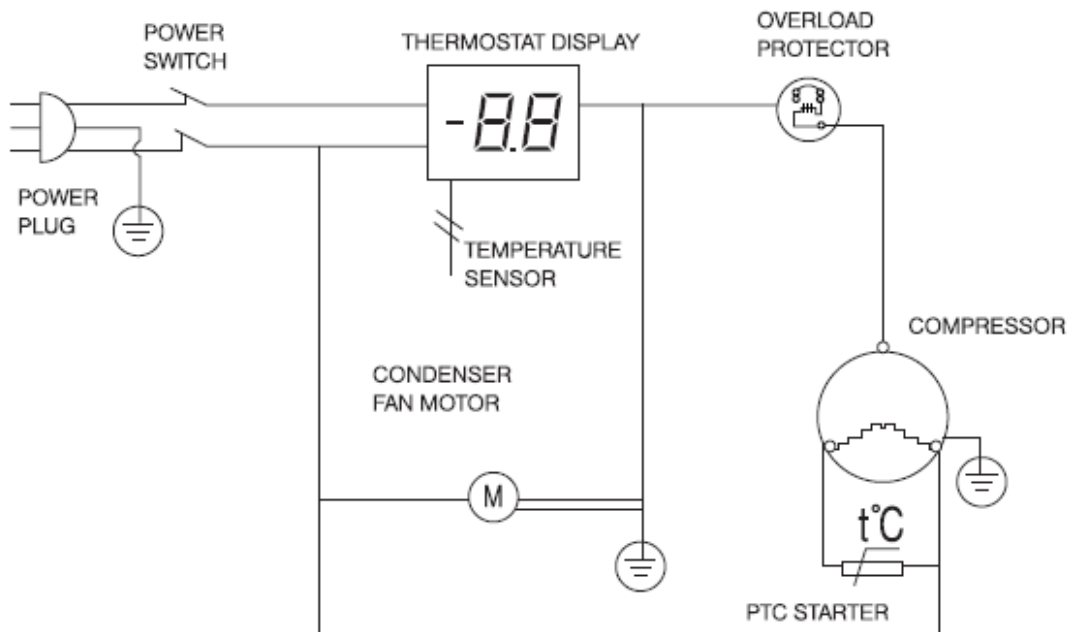

Notes

Notes